

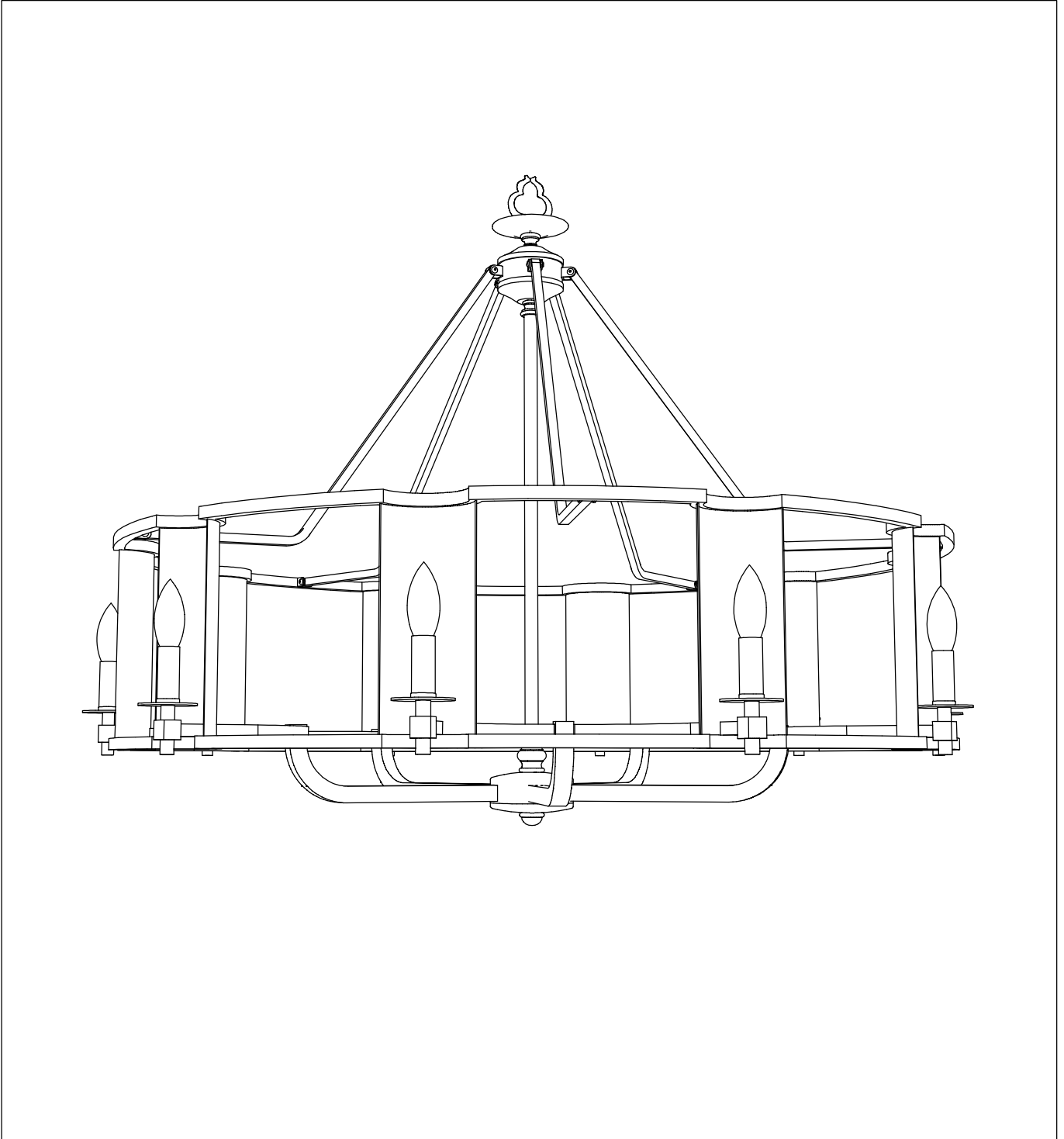

PRODUCT NAME: CANDELLA 10LT CHANDELIER

ITEM NUMBER: 30297CHBGLD

Please consult your electrician for hanging fixture and wiring.



E12 10X60W

IMPORTANT: Turn off the power at the main fuse or circuit breaker box before starting installation.

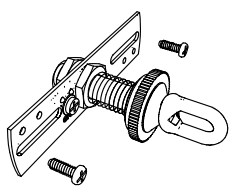

Mounting Strap (A)

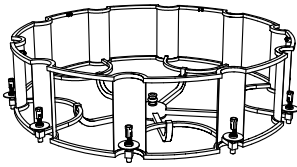

Body (B)

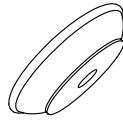

Canopy (C)



Chain (D)



Candel Tube (E)



Column (F)

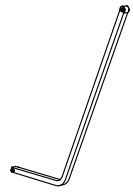

Rod (G)

Locate all hardware & components before discarding packaging

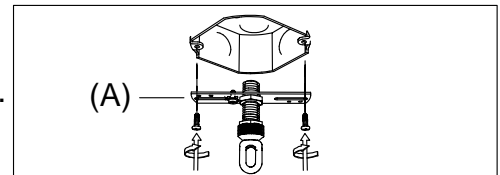
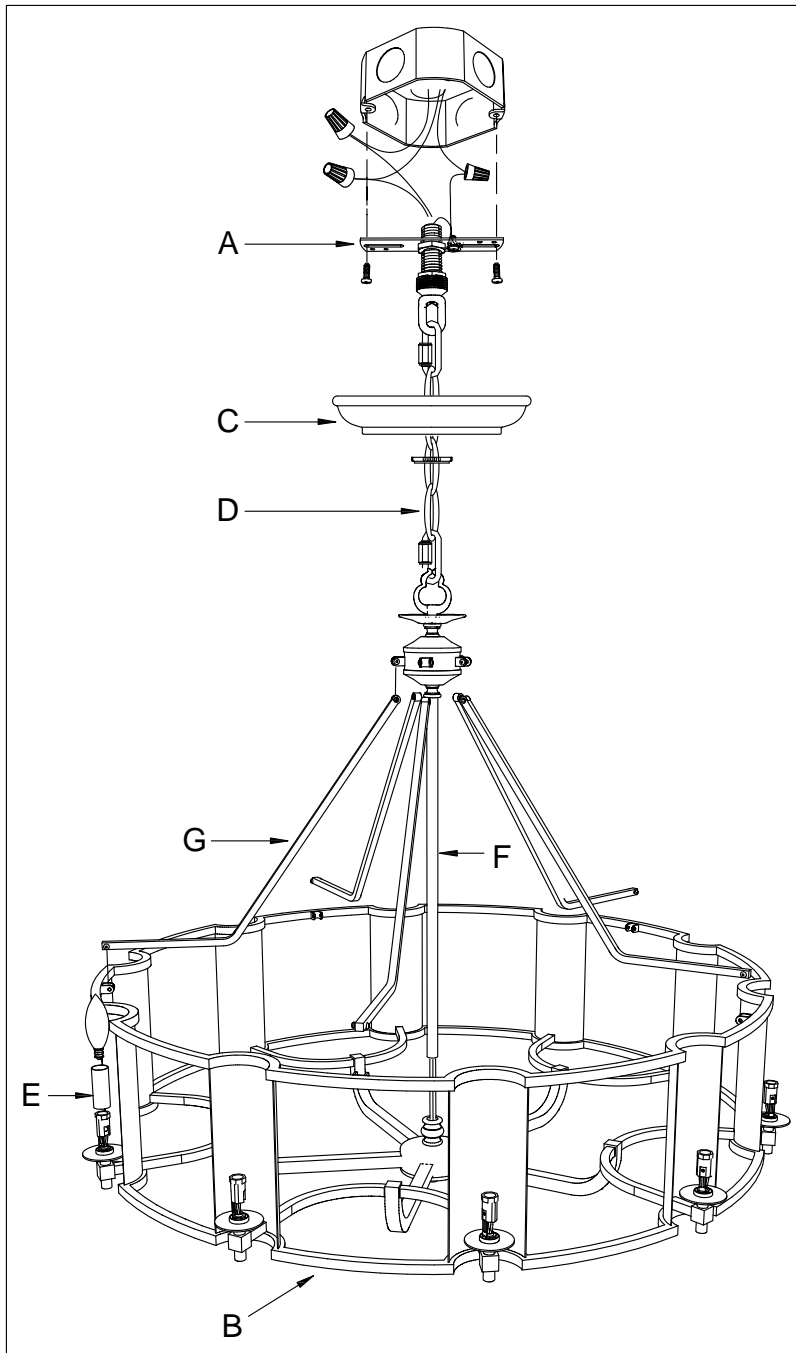

1).

Step.1: Remove mounting bracket (A) from fixture and install to electrical box.

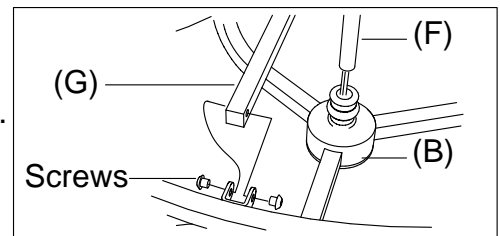

2).

Step.2: Install cloumn(F) into coupling of body (B). Secure rod(G) on the body(B) and cloumn(F) with screws.

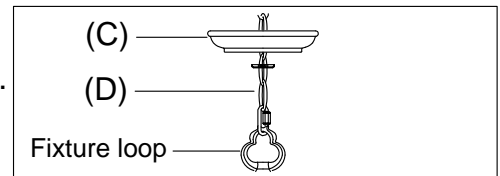

3).

Step.3: Connect chain (D) to fixture loop and canopy loop with key link.Thread fixture wire through the chain (D) into outlet box.

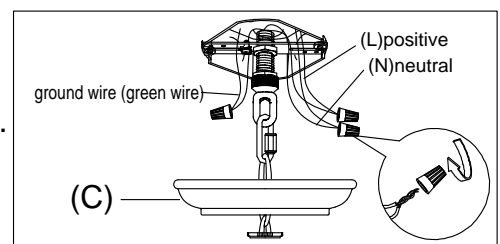

4).

Step.4: Wire fixture to wires in outlet box. Copper wire is for Ground.

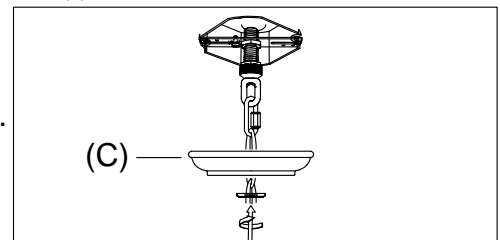

5).

Step.5: Raise Canopy(C) to ceiling and secure with canopy loop ring. Place the Candle Tube(E) over the socket.Install light bulb.

Cleaning & Care:

Clean with soft cloth and a mild detergent.
Do not use abrasive cleaner.